

1

1

1

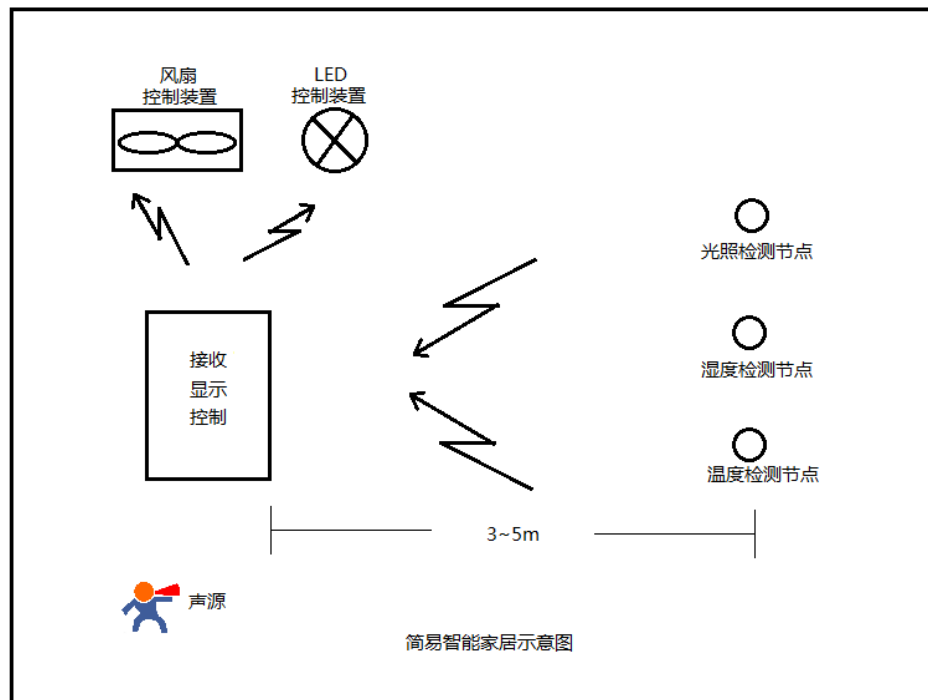

(1)

0 +50

2

(2)

(3)

4

(1)

(2)

(3)

"

"

1 °C °C °C

(2) LED

(3)

(4)

			5
			10
			20
			10
			5
			50
	1		15
	2		15
	3		20
			50
	1		10
	2		10
	3		10
	4		10
	5		10
			50

1

1

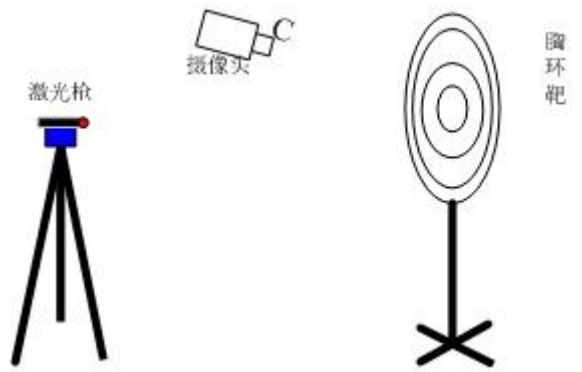

2

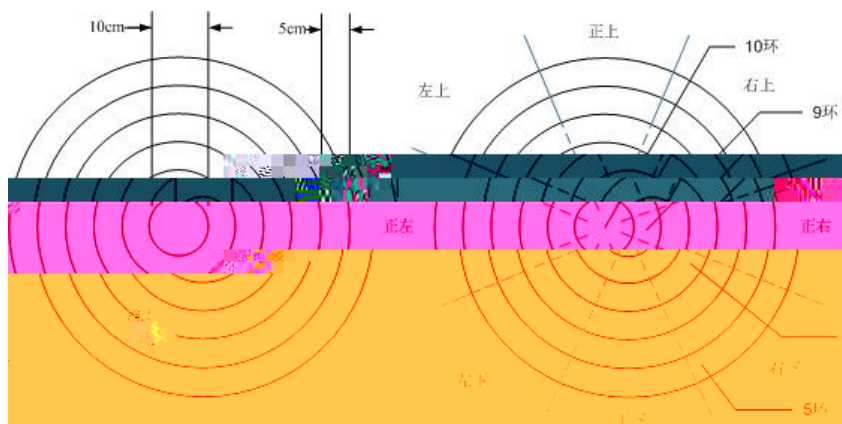

			4
			6
			4
			3
			3
			5
			20
			15
			10

•

•

1

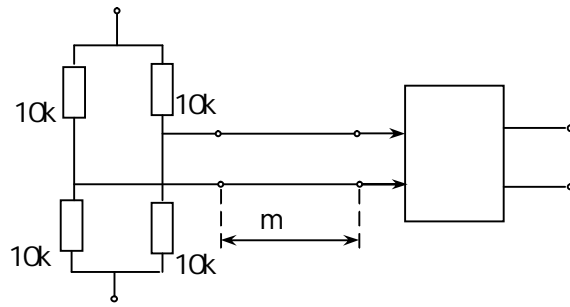

•

\pm

Ω

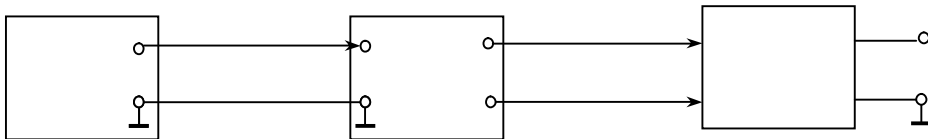

È

Ù1000

Ú

+@Xóiuí1 ð ™€ 2^uy ,€

		40
		50
		10
		30
		20

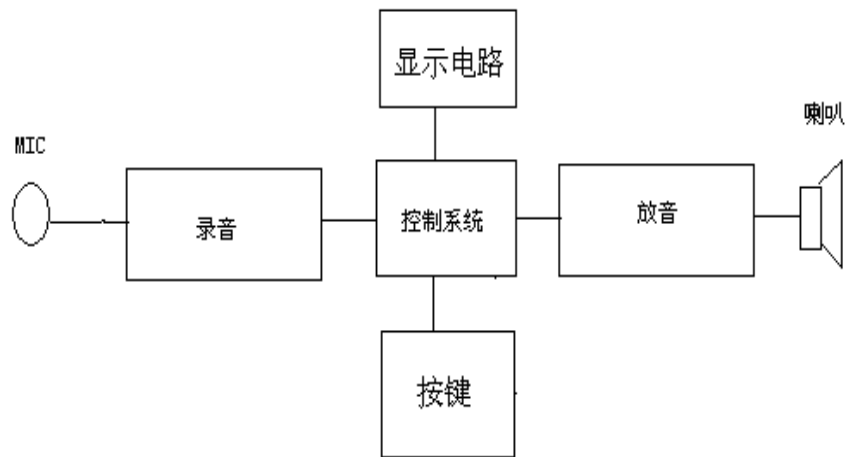

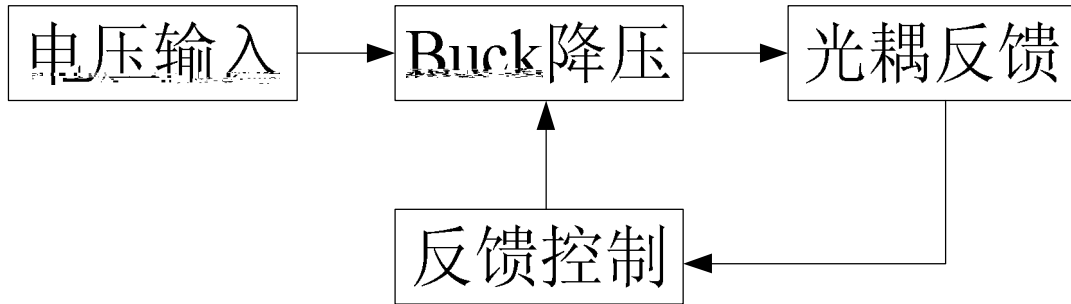

		35
		55
		10
		30
		20